



Valeo Small *TM* Range Catalogue

Let's discover Valeo Range

How to select the right Valeo TM compressor ?

1/ Choose your Mounting

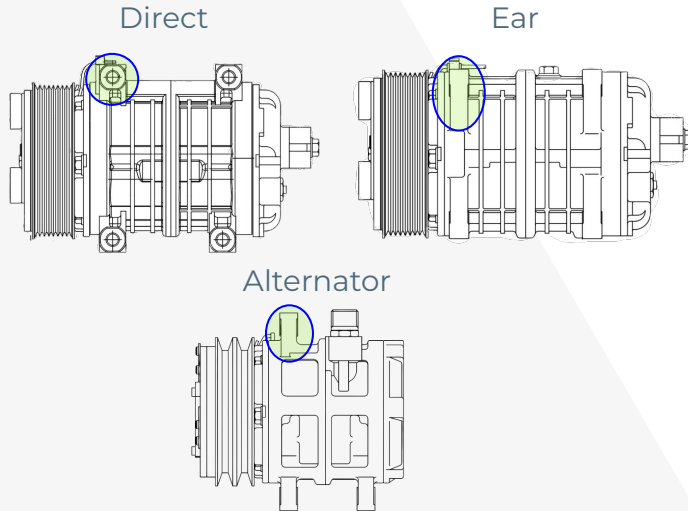

2/ Choose your Oil

- **ZXL100PG** (PAG46) for R134a
- **VC100YF** (PAG46) for R134a/R1234yf
- **SEZ68** (POE68) for R404a/R452a
- **No oil*** means that the compressor is pre-charged with residual quantity of mineral oil.

**Customer is responsible to fill it with the suitable oil for R1234yf, R134a, R404a and R452a usage.*

3/ Choose your Magnetic clutch

Voltage: 12V or 24V

Coil: : 1 or 2 wires

Armature plate: 3-eye rubber dumper (3E) or Leaf Spring (LS)

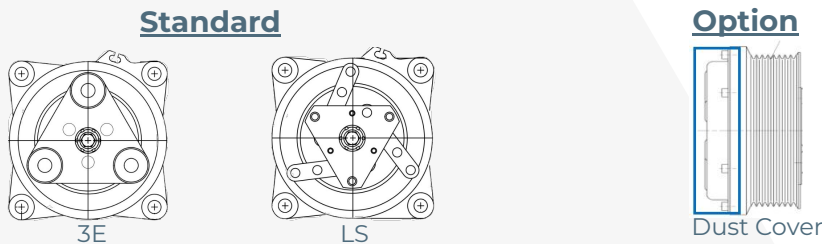

Pulley groove:

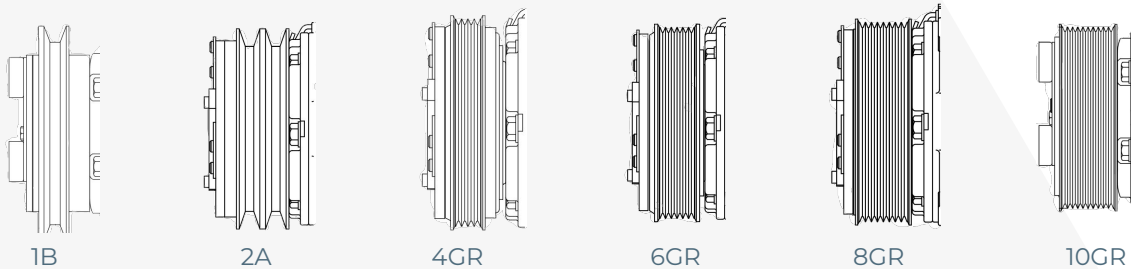

4/ Choose your Fitting

Monolithic

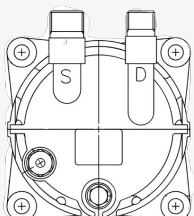

No fitting

PAD

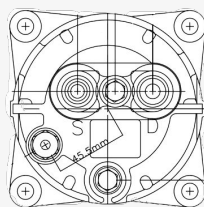

Horizontal
O'ring: $\frac{3}{4} \times \frac{7}{8}$
Tube "o": 1 x 14

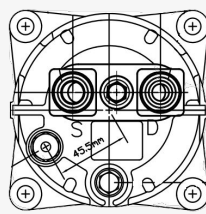

Bolt-on

Vertical
O'ring: $\frac{3}{4} \times \frac{7}{8}$
Tube "o": 1 x 14

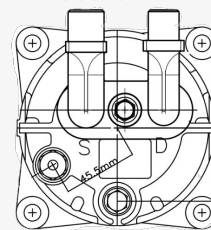

Vertical Inverted

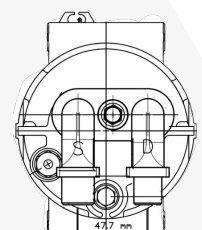

Valeo Small TM Range Catalogue - TM08

Part Number	Body			Clutch					Fitting / Manifold		
	Mount	Type	Oil	Type	Diam ext (Diam groove)	Armature	Volt.	Coil wire	Orientation	Type	Size
N204908C	Altern	Monolithic	ZXL100PG	2AG	135	3E	12V	1	None	-	-
C211042K	Altern	Monolithic	ZXL100PG	2AG	135	LS	12V	1	None	-	-
C211156A	Altern	Monolithic	ZXL100PG	2AG	125	LS	12V	1	None	-	-
N205015V	Altern	Monolithic	ZXL100PG	2AG	135	3E	24V	1	None	-	-
C218046H	Ear	Bolt-on	ZXL100PG	2AG	135	3E	12V	1	Horiz	tube "o"	1 X 14
C216146U	Ear	Bolt-on	ZXL100PG	2AG	135	3E	12V	1	Horiz	O'Ring	3/4 x 7/8
C216059D	Ear	Bolt-on	ZXL100PG	2AG	135	3E	12V	1	Vert	O'Ring	3/4 x 7/8
N204961U	Ear	Monolithic	ZXL100PG	2AG	135	3E	12V	1	None	-	-
C215019A	Ear	Bolt-on	No oil	2AG	125	LS	12V	1	None	-	-
C211152W	Ear	Monolithic	ZXL100PG	2AG	135	3E	24V	1	None	-	-
C216144S	Ear	Bolt-on	ZXL100PG	4GR	123	LS	24V	1	Horiz	O'Ring	3/4 x 7/8
C222010J	Ear	Bolt-on	SEZ68	6GR	123	3E	12V	1	Horiz	O'Ring	3/4 x 7/8
C216136J	Ear	Bolt-on	ZXL100PG	6GR	123	3E	12V	1	Horiz	O'Ring	3/4 x 7/8
C216137K	Ear	Bolt-on	No oil	6GR	123	3E	12V	1	Horiz	O'Ring	3/4 x 7/8
C216084E	Ear	Bolt-on	ZXL100PG	8GR	123	3E	12V	1	Vert	O'Ring	3/4 x 7/8
C216080A	Ear	Bolt-on	No oil	8GR	123	3E	12V	1	Vert	O'Ring	3/4 x 7/8

To access more **TM08** technical information and service manual.



Valeo Small TM Range Catalogue - TM13

Part Number	Body			Clutch					Fitting / Manifold		
	Mount	Type	Oil	Type	Diam ext (Diam groove)	Armature	Volt.	Coil wire	Orientation	Type	Size
C218237K	Ear	Bolt-on	No oil	2AG	135	3E	12V	1	Horiz	O'Ring	3/4 x 7/8
C218236J	Ear	Bolt-on	No oil	2AG	135	3E	12V	1	Horiz	tube "o"	1 X 14
C216129B	Ear	Bolt-on	ZXL100PG	2AG	135	3E	12V	1	Horiz	O'Ring	3/4 x 7/8
C218242R	Ear	Bolt-on	No oil	2AG	135	3E	12V	1	Horiz	tube "o"	1 X 14
C218244U	Ear	Bolt-on	No oil	2AG	125	LS	12V	1	Horiz	tube "o"	1 X 14
C218227Z	Ear	Bolt-on	No oil	2AG	135	3E	12V	1	Vert	O'Ring	3/4 x 7/8
C216107D	Ear	Bolt-on	ZXL100PG	2AG	125	LS	12V	1	Vert	O'Ring	3/4 x 7/8
C218235H	Ear	Bolt-on	No oil	2AG	125	LS	12V	1	Vert	O'Ring	3/4 x 7/8
C218223U	Ear	Bolt-on	No oil	2AG	135	3E	12V	1	None	-	-
N205291V	Ear	Bolt-on	ZXL100PG	2AG	135	3E	12V	1	None	-	-
C216173X	Ear	Bolt-on	ZXL100PG	2AG	135	3E	24V	1	Horiz	O'Ring	3/4 x 7/8
C218238L	Ear	Bolt-on	No oil	2AG	135	3E	24V	1	Horiz	O'Ring	3/4 x 7/8
C216020N	Ear	Bolt-on	ZXL100PG	2AG	135	3E	24V	1	Vert	O'Ring	3/4 x 7/8
C218228A	Ear	Bolt-on	No oil	2AG	135	3E	24V	1	Vert	O'Ring	3/4 x 7/8
C217278U	Ear	Bolt-on	ZXL100PG	2AG	135	LS	24V	1	Vert	O'Ring	3/4 x 7/8
C216167R	Ear	Bolt-on	ZXL100PG	8GR	123	3E	12V	1	Horiz	O'Ring	3/4 x 7/8
C218055U	Ear	Bolt-on	ZXL100PG	8GR	123	3E	12V	1	Horiz	tube "o"	1 X 14
C218243T	Ear	Bolt-on	No oil	8GR	123	3E	12V	1	Horiz	tube "o"	1 X 14
C218275F	Ear	Bolt-on	No oil	8GR	123	3E	12V	1	Vert	O'Ring	3/4 x 7/8
C216091M	Ear	Bolt-on	ZXL100PG	8GR	123	3E	12V	1	Vert	O'Ring	3/4 x 7/8
C218222T	Ear	Bolt-on	No oil	8GR	123	3E	12V	1	Vert	tube "o"	1 X 14
N205306X	Ear	Bolt-on	ZXL100PG	8GR	123	3E	12V	1	None	-	-
C218220P	Ear	Bolt-on	No oil	8GR	123	3E	12V	1	None	-	-
C218276E	Ear	Bolt-on	No oil	8GR	123	3E	24V	1	Vert	O'Ring	3/4 x 7/8
N205307T	Ear	Bolt-on	ZXL100PG	8GR	123	3E	24V	1	None	-	-
C218225X	Ear	Bolt-on	No oil	8GR	123	3E	24V	1	None	-	-

Valeo Small TM Range Catalogue - TM15

Part Number	Body			Clutch					Fitting / Manifold		
	Mount	Type	Oil	Type	Diam ext (Diam groove)	Armature	Volt.	Coil wire	Orientation	Type	Size
C217063P	Direct	Bolt-on	ZXL100PG	2AG	135	3E	12V	1	Vert	O'Ring	3/4 x 7/8
C216135H	Direct	Bolt-on	ZXL100PG	8GR	123	LS	12V	1	Horiz	O'Ring	3/4 x 7/8
C216046P	Direct	Bolt-on	ZXL100PG	8GR	123	3E	12V	1	Vert	O'Ring	3/4 x 7/8
C216019M	Direct	Bolt-on	ZXL100PG	8GR	123	3E	24V	1	Vert	O'Ring	3/4 x 7/8
C216163M	Ear	Bolt-on	ZXL100PG	2AG	125	LS	12V	1	Horiz	O'Ring	3/4 x 7/8
C218265U	Ear	Bolt-on	No oil	2AG	135	3E	12V	1	Horiz	O'Ring	3/4 x 7/8
C216162L	Ear	Bolt-on	ZXL100PG	2AG	135	3E	12V	1	Horiz	O'Ring	3/4 x 7/8
C218270A	Ear	Bolt-on	No oil	2AG	135	3E	12V	1	Horiz	tube "o"	1 X 14
C218268Y	Ear	Bolt-on	No oil	2AG	125	LS	12V	1	Horiz	O'Ring	3/4 x 7/8
C218253E	Ear	Bolt-on	No oil	2AG	135	3E	12V	1	Vert	O'Ring	3/4 x 7/8
C216085F	Ear	Bolt-on	ZXL100PG	2AG	135	3E	12V	1	Vert	O'Ring	3/4 x 7/8
C218263R	Ear	Bolt-on	No oil	2AG	135	3E	12V	1	Vert	O'Ring	3/4 x 7/8
C218269Z	Ear	Bolt-on	No oil	2AG	135	LS	12V	1	Vert	O'Ring	3/4 x 7/8
C216036E	Ear	Bolt-on	ZXL100PG	2AG	125	LS	12V	1	Vert	O'Ring	3/4 x 7/8
C218257J	Ear	Bolt-on	No oil	2AG	125	LS	12V	1	Vert	O'Ring	3/4 x 7/8
C216055Z	Ear	Bolt-on	ZXL100PG	2AG	135	LS	12V	1	Vert	O'Ring	3/4 x 7/8
C218249A	Ear	Bolt-on	No oil	2AG	135	3E	12V	1	Vert	tube "o"	1 X 14
C210204F	Ear	Monolithic	ZXL100PG	2AG	125	LS	12V	1	None	-	-
C218245W	Ear	Bolt-on	No oil	2AG	135	3E	12V	1	None	-	-
N205308H	Ear	Bolt-on	ZXL100PG	2AG	135	3E	12V	1	None	-	-
C216307W	Ear	Monolithic	ZXL100PG	2AG	135	LS	12V	1	None	-	-
N204732A	Ear	Monolithic	ZXL100PG	2AG	135	3E	12V	1	None	-	-
C219341K	Ear	Bolt-on	ZXL100PG	2AG	135	LS	12V	1	None	-	-
C218264T	Ear	Bolt-on	No oil	2AG	135	3E	24V	1	Horiz	O'Ring	3/4 x 7/8
C218039A	Ear	Bolt-on	ZXL100PG	2AG	135	3E	24V	1	Horiz	tube "o"	1 X 14
C218035W	Ear	Bolt-on	ZXL100PG	2AG	125	LS	24V	1	Horiz	tube "o"	1 X 14
C216105B	Ear	Bolt-on	ZXL100PG	2AG	135	3E	24V	1	Vert	O'Ring	3/4 x 7/8

Valeo Small TM Range Catalogue - TM15

Part Number	Body			Clutch					Fitting / Manifold		
	Mount	Type	Oil	Type	Diam ext/ Diam groove	Armature	Volt.	Coil wire	Orientation	Type	Size
C218254F	Ear	Bolt-on	No oil	2AG	135	3E	24V	1	Vert	O'Ring	3/4 x 7/8
C218247Y	Ear	Bolt-on	No oil	2AG	135	3E	24V	1	None	-	-
N205309C	Ear	Bolt-on	ZXL100PG	2AG	135	3E	24V	1	None	-	-
C222068X	Ear	Monolithic	ZXL100PG	6GR	123	LS	12V	1	Vert	O'Ring	3/4 x 7/8
C211113F	Ear	Monolithic	ZXL100PG	6GR	123	3E	12V	1	None	-	-
C221176N	Ear	Monolithic	VC100YF	6GR	123	3E	12V	1	None	-	-
C218266W	Ear	Bolt-on	No oil	8GR	123	3E	12V	1	Horiz	O'Ring	3/4 x 7/8
C216161K	Ear	Bolt-on	ZXL100PG	8GR	123	3E	12V	1	Horiz	O'Ring	3/4 x 7/8
C218054T	Ear	Bolt-on	ZXL100PG	8GR	123	3E	12V	1	Horiz	tube "o"	1 X 14
C218272C	Ear	Bolt-on	No oil	8GR	123	3E	12V	1	Horiz	tube "o"	1 X 14
C221316P	Ear	Bolt-on	VC100YF	8GR	123	3E	12V	1	Horiz	O'Ring	3/4 x 7/8
C218255G	Ear	Bolt-on	No oil	8GR	123	3E	12V	1	Vert	O'Ring	3/4 x 7/8
C216087H	Ear	Bolt-on	ZXL100PG	8GR	123	3E	12V	1	Vert	O'Ring	3/4 x 7/8
C218262P	Ear	Bolt-on	No oil	8GR	123	LS	12V	1	Vert	O'Ring	3/4 x 7/8
C216047R	Ear	Bolt-on	ZXL100PG	8GR	123	LS	12V	1	Vert	O'Ring	3/4 x 7/8
C221317R	Ear	Bolt-on	VC100YF	8GR	123	3E	12V	1	Vert	O'Ring	3/4 x 7/8
C218246X	Ear	Bolt-on	No oil	8GR	123	3E	12V	1	None	-	-
N205310R	Ear	Bolt-on	ZXL100PG	8GR	123	3E	12V	1	None	-	-
C211127U	Ear	Monolithic	ZXL100PG	8GR	123	LS	12V	1	None	-	-
N204808S	Ear	Monolithic	ZXL100PG	8GR	123	3E	12V	1	None	-	-
C216166P	Ear	Bolt-on	ZXL100PG	8GR	123	3E	24V	1	Horiz	O'Ring	3/4 x 7/8
C218267X	Ear	Bolt-on	No oil	8GR	123	3E	24V	1	Horiz	O'Ring	3/4 x 7/8
C216097T	Ear	Bolt-on	ZXL100PG	8GR	123	3E	24V	1	Vert	O'Ring	3/4 x 7/8
C218256H	Ear	Bolt-on	No oil	8GR	123	3E	24V	1	Vert	O'Ring	3/4 x 7/8
N205311P	Ear	Bolt-on	ZXL100PG	8GR	123	3E	24V	1	None	-	-

Valeo Small TM Range Catalogue - TM16

Part Number	Body			Clutch					Fitting / Manifold		
	Mount	Type	Oil	Type	Diam ext (Diam groove)	Armature	Volt.	Coil wire	Orientation	Type	Size
C220168Y	Direct	Bolt-on	ZXL100PG	2AG	135	3E	12V	1	Vert	O'Ring	3/4 x 7/8
C217068X	Direct	Bolt-on	ZXL100PG	2AG	135	3E	24V	1	Vert inv	0	0
C217316L	Direct	Bolt-on	ZXL100PG	6GR	123	3E	24V	1	Vert inv	0	0
C216297R	Direct	Bolt-on	ZXL100PG	8GR	123	3E	12V	1	Horiz	O'Ring	3/4 x 7/8
C216058C	Direct	Bolt-on	ZXL100PG	8GR	123	3E	12V	1	Vert	O'Ring	3/4 x 7/8
C217275P	Direct	Bolt-on	No oil	8GR	123	3E	12V	1	None	-	-
C216149X	Direct	Bolt-on	ZXL100PG	8GR	123	3E	24V	1	Horiz	O'Ring	3/4 x 7/8
C218144K	Ear	Bolt-on	No oil	2AG	135	3E	12V	1	Horiz	O'Ring	3/4 x 7/8
C218137C	Ear	Bolt-on	No oil	2AG	135	3E	12V	1	Vert	O'Ring	3/4 x 7/8
C216128A	Ear	Bolt-on	ZXL100PG	2AG	135	3E	12V	1	Horiz	O'Ring	3/4 x 7/8
C218033U	Ear	Bolt-on	ZXL100PG	2AG	125	LS	12V	1	Horiz	tube "o"	1 X 14
C218153V	Ear	Bolt-on	No oil	2AG	135	3E	12V	1	Horiz	tube "o"	1 X 14
C216175Z	Ear	Bolt-on	ZXL100PG	2AG	135	3E	12V	1	Horiz	O'Ring	3/4 x 7/8
C216168S	Ear	Bolt-on	ZXL100PG	2AG	135	3E	24V	1	Horiz	O'Ring	3/4 x 7/8
C218145L	Ear	Bolt-on	No oil	2AG	135	3E	24V	1	Horiz	O'Ring	3/4 x 7/8
C218059Y	Ear	Bolt-on	ZXL100PG	2AG	135	3E	24V	1	Horiz	tube "o"	1 X 14
C218029N	Ear	Bolt-on	ZXL100PG	2AG	125	LS	24V	1	Horiz	tube "o"	1 X 14
C218155X	Ear	Bolt-on	No oil	2AG	135	3E	24V	1	Horiz	tube "o"	1 X 14
C216043M	Ear	Bolt-on	ZXL100PG	2AG	135	3E	12V	1	Vert	O'Ring	3/4 x 7/8
C218309C	Ear	Bolt-on	No oil	2AG	135	LS	12V	1	Vert	O'Ring	3/4 x 7/8
C216098U	Ear	Bolt-on	ZXL100PG	2AG	125	LS	12V	1	Vert	O'Ring	3/4 x 7/8
C219129H	Ear	Bolt-on	No oil	2AG	125	LS	12V	1	Vert	O'Ring	3/4 x 7/8
C218099B	Ear	Bolt-on	No oil	2AG	135	3E	12V	1	Vert	tube "o"	1 X 14
C216075V	Ear	Bolt-on	ZXL100PG	2AG	135	LS	12V	1	Vert	O'Ring	3/4 x 7/8
C216106C	Ear	Bolt-on	ZXL100PG	2AG	135	3E	24V	1	Vert	O'Ring	3/4 x 7/8
C218136B	Ear	Bolt-on	No oil	2AG	135	3E	24V	1	Vert	O'Ring	3/4 x 7/8
C218157Z	Ear	Bolt-on	No oil	2AG	135	3E	24V	1	Vert	tube "o"	1 X 14

Valeo Small TM Range Catalogue - TM16

Part Number	Body			Clutch					Fitting / Manifold		
	Mount	Type	Oil	Type	Diam ext (Diam groove)	Armature	Volt.	Coil wire	Orientation	Type	Size
C216076W	Ear	Bolt-on	ZXL100PG	2AG	135	LS	24V	1	Vert	O'Ring	3/4 x 7/8
C219042L	Ear	Bolt-on	No oil	2AG	135	3E	12V	1	No	-	-
N205315E	Ear	Bolt-on	ZXL100PG	2AG	135	3E	12V	1	No	-	-
N204992S	Ear	Monolithic	ZXL100PG	2AG	135	3E	12V	1	No	-	-
C218350F	Ear	Bolt-on	No oil	2AG	135	3E	24V	1	No	-	-
N205316W	Ear	Bolt-on	ZXL100PG	2AG	135	3E	24V	1	No	-	-
C219377F	Ear	Monolithic	No oil	2AG	135	3E	24V	1	No	-	-
C209048F	Ear	Monolithic	ZXL100PG	2AG	135	3E	24V	1	No	-	-
C220278P	Ear	Bolt-on	No oil	4GR	123	LS	12V	1	Horiz	O'Ring	3/4 x 7/8
C220277N	Ear	Bolt-on	No oil	4GR	123	LS	12V	1	Vert	O'Ring	3/4 x 7/8
C216232M	Ear	Bolt-on	ZXL100PG	6GR	123	LS	12V	1	Horiz	O'Ring	3/4 x 7/8
C216042L	Ear	Bolt-on	ZXL100PG	6GR	123	3E	12V	1	Vert	O'Ring	3/4 x 7/8
C215310J	Ear	Monolithic	ZXL100PG	6GR	123	LS	12V	1	No	-	-
C211060A	Ear	Monolithic	ZXL100PG	6GR	123	3E	12V	1	No	-	-
C218147N	Ear	Bolt-on	No oil	8GR	123	3E	12V	1	Horiz	O'Ring	3/4 x 7/8
C216170U	Ear	Bolt-on	ZXL100PG	8GR	123	3E	12V	1	Horiz	O'Ring	3/4 x 7/8
C216171V	Ear	Bolt-on	ZXL100PG	8GR	123	3E	24V	1	Horiz	O'Ring	3/4 x 7/8
C218146M	Ear	Bolt-on	No oil	8GR	123	3E	24V	1	Horiz	O'Ring	3/4 x 7/8
C218154W	Ear	Bolt-on	No oil	8GR	123	3E	12V	1	Horiz	tube "o"	1 X 14
C218045G	Ear	Bolt-on	ZXL100PG	8GR	123	3E	24V	1	Horiz	tube "o"	1 X 14
C216088J	Ear	Bolt-on	ZXL100PG	8GR	123	3E	12V	1	Vert	O'Ring	3/4 x 7/8
C218135A	Ear	Bolt-on	No oil	8GR	123	3E	12V	1	Vert	O'Ring	3/4 x 7/8
C216089K	Ear	Bolt-on	ZXL100PG	8GR	123	3E	24V	1	Vert	O'Ring	3/4 x 7/8
C218139E	Ear	Bolt-on	No oil	8GR	123	LS	12V	1	Vert	O'Ring	3/4 x 7/8
C218138D	Ear	Bolt-on	No oil	8GR	123	3E	24V	1	Vert	O'Ring	3/4 x 7/8
C218140F	Ear	Bolt-on	No oil	8GR	123	3E	12V	1	Vert	O'Ring	3/4 x 7/8
C216045Q	Ear	Bolt-on	ZXL100PG	8GR	123	LS	12V	1	Vert	O'Ring	3/4 x 7/8

Valeo Small TM Range Catalogue - TM16

Part Number	Body			Clutch					Fitting / Manifold		
	Mount	Type	Oil	Type	Diam ext (Diam groove)	Armature	Volt.	Coil wire	Orientation	Type	Size
C216077X	Ear	Bolt-on	ZXL100PG	8GR	123	LS	24V	1	Vert	O'Ring	3/4 x 7/8
C211005C	Ear	Monolithic	ZXL100PG	8GR	123	3E	12V	1	No	-	-
C218347D	Ear	Bolt-on	No oil	8GR	123	3E	12V	1	No	-	-
N205318M	Ear	Bolt-on	ZXL100PG	8GR	123	3E	12V	1	No	-	-
N205319J	Ear	Bolt-on	ZXL100PG	8GR	123	3E	24V	1	No	-	-
C211070K	Ear	Monolithic	ZXL100PG	8GR	123	3E	24V	1	No	-	-
C217283Y	Ear	Monolithic	ZXL100PG	8GR	123	LS	12V	1	No	-	-
C219342L	Ear	Bolt-on	ZXL100PG	8GR	123	LS	12V	1	No	-	-
C218349E	Ear	Bolt-on	No oil	8GR	123	3E	24V	1	No	-	-
C213684Q	Ear	Monolithic	No oil	8GR	123	3E	24V	1	No	-	-
C216078Y	Ear	Bolt-on	ZXL100PG	10GR	123	3E	24V	N/A	Vert	O'Ring	3/4 x 7/8



Do you know how To read a label ?

⇒ Please ask for the "Did you know number 5"

To access more **TM13/TM15/TM16** technical information and service manual.



Valeo Small TM Range Catalogue - TM21

Part Number	Body			Clutch					Fitting / Manifold		
	Mount	Type	Oil	Type	Diam ext (Diam groove)	Armature	Volt.	Coil wire	Orientation	Type	Size
C221021L	Direct	Bolt-on	No oil	1BG	150	3E	12V	2	Vert	O'Ring	3/4 x 7/8
C218158A	Direct	Bolt-on	No oil	1BG	150	3E	24V	2	Vert	O'Ring	3/4 x 7/8
C216061F	Direct	Bolt-on	ZXL100PG	1BG	150	3E	24V	1	Vert	O'Ring	3/4 x 7/8
C216083D	Direct	Bolt-on	ZXL100PG	1BG	150	3E	24V	2	Vert	O'Ring	3/4 x 7/8
C216081B	Direct	Bolt-on	ZXL100PG	1BG	159	3E	24V	2	Vert	O'Ring	3/4 x 7/8
C218024H	Direct	Bolt-on	ZXL100PG	1BG	159	3E	24V	2	None	-	-
C211218H	Direct	Bolt-on	ZXL100PG	1BG	150	3E	24V	2	None	-	-
C210042U	Direct	Bolt-on	ZXL100PG	1BG	150	3E	24V	1	None	-	-
C217104P	Direct	Bolt-on	ZXL100PG	2AG	145	3E	12V	2	Horiz	O'Ring	3/4 x 7/8
C216039H	Direct	Bolt-on	ZXL100PG	2AG	145	3E	12V	2	Vert	O'Ring	3/4 x 7/8
C208309X	Direct	Bolt-on	No oil	2AG	145	3E	12V	2	None	-	-
C815855P	Direct	Bolt-on	ZXL100PG	2AG	145	3E	12V	2	None	-	-
C216124W	Direct	Bolt-on	No oil	2AG	145	3E	24V	2	Horiz	O'Ring	3/4 x 7/8
C218048K	Direct	Bolt-on	ZXL100PG	2AG	145	3E	24V	2	Horiz	tube "o"	1 X 14
C216140N	Direct	Bolt-on	ZXL100PG	2AG	145	3E	24V	2	Horiz	O'Ring	3/4 x 7/8
C815854N	Direct	Bolt-on	ZXL100PG	2AG	145	3E	24V	2	None	-	-
C208308W	Direct	Bolt-on	No oil	2AG	145	3E	24V	2	None	-	-
C220098H	Direct	Bolt-on	ZXL100PG	4GR	125	3E	12V	2	Horiz	O'Ring	3/4 x 7/8
C210195D	Direct	Bolt-on	ZXL100PG	6GR	137	3E	12V	2	None	-	-
C219360G	Direct	Bolt-on	ZXL100PG	6GR	137	Dust Cover	24V	2	Vert	O'Ring	3/4 x 7/8
C216143R	Direct	Bolt-on	ZXL100PG	8GR	137	3E	12V	2	Horiz	O'Ring	-
C218052P	Direct	Bolt-on	ZXL100PG	8GR	137	3E	12V	2	Horiz	tube "o"	3/4 x 7/8
C216040J	Direct	Bolt-on	ZXL100PG	8GR	137	3E	12V	2	Vert	O'Ring	1 X 14
C216273K	Direct	Bolt-on	No oil	8GR	137	3E	12V	2	Vert	O'Ring	3/4 x 7/8
C217097H	Direct	Bolt-on	ZXL100PG	8GR	141 (127)	3E	12V	2	Vert	O'Ring	-
C207026B	Direct	Bolt-on	ZXL100PG	8GR	137	3E	12V	2	None	-	3/4 x 7/8
C219128G	Direct	Bolt-on	ZXL100PG	8GR	137	LS	12V	2	None	-	-

Valeo Small TM Range Catalogue - TM21

Part Number	Body			Clutch					Fitting / Manifold		
	Mount	Type	Oil	Type	Diam ext/ Diam groove	Armature	Volt.	Coil wire	Orientation	Type	Size
C213609D	Direct	Bolt-on	ZXL100PG	8GR	141 (127)	3E	12V	2	None	-	3/4 x 7/8
C211219I	Direct	Bolt-on	No oil	8GR	141 (127)	3E	12V	2	None	-	-
C216142P	Direct	Bolt-on	ZXL100PG	8GR	137	3E	24V	2	Horiz	O'Ring	3/4 x 7/8
C220189K	Direct	Bolt-on	ZXL100PG	8GR	141 (127)	LS	24V	2	Horiz	O'Ring	3/4 x 7/8
C218171H	Direct	Bolt-on	ZXL100PG	8GR	141 (127)	Dust Cover	24V	2	Horiz	O'Ring	3/4 x 7/8
C216125X	Direct	Bolt-on	No oil	8GR	137	3E	24V	2	Horiz	O'Ring	3/4 x 7/8
C217067W	Direct	Bolt-on	ZXL100PG	8GR	141 (127)	3E	24V	2	Horiz	O'Ring	3/4 x 7/8
C216056A	Direct	Bolt-on	ZXL100PG	8GR	137	3E	24V	2	Vert	O'Ring	3/4 x 7/8
C216230K	Direct	Bolt-on	ZXL100PG	8GR	141 (127)	3E	24V	1	Vert	O'Ring	3/4 x 7/8
C216060E	Direct	Bolt-on	ZXL100PG	8GR	141 (127)	3E	24V	1	Vert	O'Ring	3/4 x 7/8
C220191M	Direct	Bolt-on	No oil	8GR	141 (127)	3E	24V	2	Vert	O'Ring	3/4 x 7/8
C217066U	Direct	Bolt-on	ZXL100PG	8GR	141 (127)	Dust Cover	24V	2	Vert inv	-	-
C207027C	Direct	Bolt-on	ZXL100PG	8GR	137	3E	24V	2	None	-	-
C208290Q	Direct	Bolt-on	ZXL100PG	8GR	141 (127)	Dust Cover	24V	2	None	-	-
C209311G	Direct	Monolithic	No oil	8GR	141 (127)	3E	24V	2	None	-	-
C217093D	Direct	Bolt-on	No oil	8GR	137	3E	24V	2	None	-	-
C211202Z	Direct	Bolt-on	ZXL100PG	8GR	137	3E	24V	2	None	-	-
C210351P	Direct	Monolithic	No oil	8GR	137	3E	24V	1	None	-	-
C211003A	Direct	Monolithic	No oil	8GR	137	3E	24V	2	None	-	-
C216154C	Direct	Bolt-on	ZXL100PG	10GR	127	3E	24V	2	Horiz	O'Ring	3/4 x 7/8

To access more **TM21** technical information and service manual.

